

FLEXPO HYDRAULIC COMPONENTS

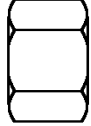

CATALOGO

RACCORDI DIN
DIN Fittings

ANELLO DI SERRAGGIO			DADO DI SERRAGGIO			
Serie	øTubo	Codice	Serie	øTubo	Filetto	Codice
LL	4	DIN88-04LL	LL	4	8X1	DIN81-04LL
	6	DIN88-06LL		6	10X1	DIN81-06LL
	8	DIN88-08LL		8	12X1	DIN81-08LL
L	6	DIN88-06L	L	6	12X1,5	DIN81-06L
	8	DIN88-08L		8	14X1,5	DIN81-08L
	10	DIN88-10L		10	16X1,5	DIN81-10L
	12	DIN88-12L		12	18X1,5	DIN81-12L
	15	DIN88-15L		15	22X1,5	DIN81-15L
	18	DIN88-18L		18	26X1,5	DIN81-18L
	22	DIN88-22L		22	30X2	DIN81-22L
	28	DIN88-28L		28	36X2	DIN81-28L
	35	DIN88-35L		35	45X2	DIN81-35L
	42	DIN88-42L		42	52X2	DIN81-42L
S	6	DIN88-06S	S	6	14X1,5	DIN81-06S
	8	DIN88-08S		8	16X1,5	DIN81-08S
	10	DIN88-10S		10	18X1,5	DIN81-10S
	12	DIN88-12S		12	20X1,5	DIN81-12S
	14	DIN88-14S		14	22X1,5	DIN81-14S
	16	DIN88-16S		16	24X1,5	DIN81-16S
	20	DIN88-20S		20	30X2	DIN81-20S
	25	DIN88-25S		25	36X2	DIN81-25S
	30	DIN88-30S		30	42X2	DIN81-30S
	38	DIN88-38S		38	52X2	DIN81-38S

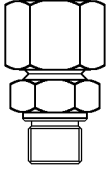
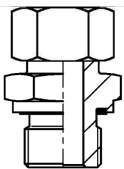
DIRITTO DI ESTREMITA'			 Diritto Estremità Gas Cilindrico Serie L	 Diritto Estremità Gas Cilindrico Guarn. Piana Serie L
Serie	øTubo	Filetto	Codice	Codice
L	4	1/8"	DIN92-04LLG02	DIN92-04ELLG02
	6	1/8"	DIN92-06LLG02	DIN92-06ELLG02
	8	1/8"	DIN92-08LLG02	DIN92-08ELLG02
	6	1/8"	DIN92-06LG02	DIN92-06ELG02
	6	1/4"	DIN92-06LG04	DIN92-06ELG04
	6	3/8"	DIN92-06LG06	DIN92-06ELG06
	8	1/8"	DIN92-08LG02	DIN92-08ELG02
	8	1/4"	DIN92-08LG04	DIN92-08ELG04
	8	3/8"	DIN92-08LG06	DIN92-08ELG06
	8	1/2"	DIN92-08LG08	DIN92-08ELG08
	10	1/8"	DIN92-10LG02	DIN92-10ELG02
	10	1/4"	DIN92-10LG04	DIN92-10ELG04
	10	3/8"	DIN92-10LG06	DIN92-10ELG06
	10	1/2"	DIN92-10LG08	DIN92-10ELG08
	12	1/4"	DIN92-12LG04	DIN92-12ELG04
	12	3/8"	DIN92-12LG06	DIN92-12ELG06
	12	1/2"	DIN92-12LG08	DIN92-12ELG08
	15	3/8"	DIN92-15LG06	DIN92-15ELG06
	15	1/2"	DIN92-15LG08	DIN92-15ELG08
	15	3/4"	DIN92-15LG12	DIN92-15ELG12
	18	1/2"	DIN92-18LG08	DIN92-18ELG08
	18	3/4"	DIN92-18LG12	DIN92-18ELG12
	22	1/2"	DIN92-22LG08	DIN92-22ELG08
	22	3/4"	DIN92-22LG12	DIN92-22ELG12
	22	1"	DIN92-22LG16	DIN92-22ELG16
	28	3/4"	DIN92-28LG12	DIN92-28ELG12
	28	1"	DIN92-28LG16	DIN92-28ELG16
	35	1"	DIN92-35LG16	DIN92-35ELG16
	35	1.1/4"	DIN92-35LG20	DIN92-35ELG20
	42	1.1/4"	DIN92-42LG20	DIN92-42ELG20
	42	1.1/2"	DIN92-42LG24	DIN92-42ELG24

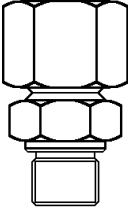
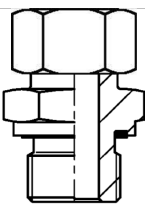
DIRITTO DI ESTREMITA'			 Diritto Estremità Gas Cilindrico Serie S	 Diritto Estremità Gas Cilindrico Guarn. Piana Serie S
Serie	øTubo	Filetto	Codice	Codice
S	6	1/4"	DIN92-06SG04	DIN92-06ESG04
	8	1/4"	DIN92-08SG04	DIN92-08ESG04
	8	3/8"	DIN92-08SG06	DIN92-08ESG06
	10	1/4"	DIN92-10SG04	DIN92-10ESG04
	10	3/8"	DIN92-10SG06	DIN92-10ESG06
	10	1/2"	DIN92-10SG08	DIN92-10ESG08
	12	1/4"	DIN92-12SG04	DIN92-12ESG04
	12	3/8"	DIN92-12SG06	DIN92-12ESG06
	12	1/2"	DIN92-12SG08	DIN92-12ESG08
	14	3/8"	DIN92-14SG06	DIN92-14ESG06
	14	1/2"	DIN92-14SG08	DIN92-14ESG08
	16	3/8"	DIN92-16SG06	DIN92-16ESG06
	16	1/2"	DIN92-16SG08	DIN92-16ESG08
	16	3/4"	DIN92-16SG12	DIN92-16ESG12
	20	1/2"	DIN92-20SG08	DIN92-20ESG08
	20	3/4"	DIN92-20SG12	DIN92-20ESG12
	20	1"	DIN92-20SG16	DIN92-20ESG16
	25	3/4"	DIN92-25SG12	DIN92-25ESG12
	25	1"	DIN92-25SG16	DIN92-25ESG16
	30	1"	DIN92-30SG16	DIN92-30ESG16
	30	1.1/4"	DIN92-30SG20	DIN92-30ESG20
	38	1.1/4"	DIN92-38SG20	DIN92-38ESG20
	38	1.1/2"	DIN92-38SG24	DIN92-38ESG24

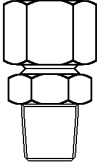
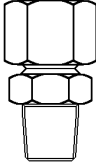
DIRITTO DI ESTREMITA'			 Diritto Estremità Gas Conico Serie L				 Diritto Estremità Gas Conico Serie S
Serie	øTubo	Filetto	Codice	Serie	øTubo	Filetto	Codice
L	4	1/8"	DIN93-04LLC02	S	6	1/4"	DIN93-06SC04
	6	1/8"	DIN93-06LLC02		8	1/4"	DIN93-08SC04
	8	1/8"	DIN93-08LLC02		8	3/8"	
	6	1/8"	DIN93-06LC02		10	1/4"	
	6	1/4"	DIN93-06LC04		10	3/8"	DIN93-10SC06
	6	3/8"			10	1/2"	
	8	1/8"	DIN93-08LC02		12	1/4"	
	8	1/4"	DIN93-08LC04		12	3/8"	DIN93-12SC06
	8	3/8"	DIN93-08LC06		12	1/2"	DIN93-12SC08
	8	1/2"	DIN93-08LC08		14	3/8"	DIN93-14SC06
	10	1/8"	DIN93-10LC02		14	1/2"	DIN93-14SC08
	10	1/4"	DIN93-10LC04		16	3/8"	DIN93-16SC06
	10	3/8"	DIN93-10LC06		16	1/2"	DIN93-16SC08
	10	1/2"	DIN93-10LC08		16	3/4"	
	12	1/4"	DIN93-12LC04		20	1/2"	DIN93-20SC08
	12	3/8"	DIN93-12LC06		20	3/4"	DIN93-20SC12
	12	1/2"	DIN93-12LC08		20	1"	
	15	3/8"	DIN93-15LC06		25	3/4"	DIN93-25SC12
	15	1/2"	DIN93-15LC08		25	1"	DIN93-25SC16
	15	3/4"			30	1"	DIN93-30SC16
	18	1/2"	DIN93-18LC08		30	1.1/4"	DIN93-30SC20
	18	3/4"	DIN93-18LC12		38	1.1/4"	
	22	1/2"			38	1.1/2"	DIN93-38SC24
	22	3/4"	DIN93-22LC12				
	22	1"					
	28	3/4"					
	28	1"	DIN93-28LC16				
	35	1"					
	35	1.1/4"	DIN93-35LC20				
	42	1.1/2"	DIN93-42LC24				

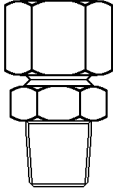
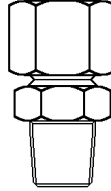
DIRITTO DI ESTREMITA'			 Diritto Estremità NPT Serie L				 Diritto Estremità NPT Serie S
Serie	øTubo	Filetto	Codice	Serie	øTubo	Filetto	Codice
L	6	1/8"	DIN93-06LN02	S	6	1/4"	DIN93-06SN04
	6	1/4"	DIN93-06LN04		8	1/4"	DIN93-08SN04
	8	1/8"	DIN93-08LN02		10	3/8"	DIN93-10SN06
	8	1/4"	DIN93-08LN04		12	3/8"	DIN93-12SN06
	8	3/8"	DIN93-08LN06		12	1/2"	DIN93-12SN08
	8	1/2"	DIN93-08LN08		14	3/8"	DIN93-14SN06
	10	1/8"	DIN93-10LN02		14	1/2"	DIN93-14SN08
	10	1/4"	DIN93-10LN04		16	3/8"	DIN93-16SN06
	10	3/8"	DIN93-10LN06		16	1/2"	DIN93-16SN08
	10	1/2"	DIN93-10LN08		20	1/2"	DIN93-20SN08
	12	1/4"	DIN93-12LN04		20	3/4"	DIN93-20SN12
	12	3/8"	DIN93-12LN06		25	3/4"	DIN93-25SN12
	12	1/2"	DIN93-12LN08		25	1"	DIN93-25SN16
	15	3/8"	DIN93-15LN06		30	1"	DIN93-30SN16
	15	1/2"	DIN93-15LN08		30	1.1/4"	DIN93-30SN20
	18	1/2"	DIN93-18LN08		38	1.1/2"	DIN93-38SN24
	18	3/4"	DIN93-18LN12				
	22	3/4"	DIN93-22LN12				
	28	1"	DIN93-28LN16				
	35	1.1/4"	DIN93-35LN20				
	42	1.1/2"	DIN93-42LN24				

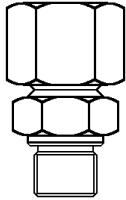
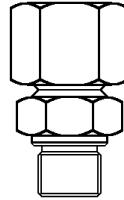
DIRITTO DI ESTREMITA'							
Serie	øTubo	Filetto	Codice	Serie	øTubo	Filetto	Codice
LL	4	8X1	DIN92-04LLM08C	S	6	12X1,5	DIN92-06SM12A
	6	10X1	DIN92-06LLM10C		8	14X1,5	DIN92-08SM14A
	8	10X1	DIN92-08LLM10C		10	16X1,5	DIN92-10SM16A
L	6	10X1	DIN92-06LM10C		12	18X1,5	DIN92-12SM18A
	8	10X1	DIN92-08LM10C		12	22X1,5	DIN92-12SM22A
	8	12X1,5	DIN92-08LM12A		14	20X1,5	DIN92-14SM20A
	8	18X1,5	DIN92-08LM18A		16	18X1,5	DIN92-16SM18A
	10	14X,15	DIN92-10LM14A		16	22X1,5	DIN92-16SM22A
	10	16X1,5	DIN92-10LM16A		20	22X1,5	DIN92-20SM22A
	10	18X1,5	DIN92-10LM18A		20	27X2	DIN92-20SM27B
	10	22X1,5	DIN92-10LM22A		25	27X2	DIN92-25SM27B
	12	14X,15	DIN92-12LM14A		25	33X2	DIN92-25SM33B
	12	16X1,5	DIN92-12LM16A		30	33X2	DIN92-30SM33B
	12	18X1,5	DIN92-12LM18A		30	42X2	DIN92-30SM42B
	12	22X1,5	DIN92-12LM22A		38	48X2	DIN92-38SM48B
	15	16X1,5	DIN92-15LM16A				
	15	18X1,5	DIN92-15LM18A				
	15	22X1,5	DIN92-15LM22A				
	18	18X1,5	DIN92-18LM18A				
	18	22X1,5	DIN92-18LM22A				
	22	22X1,5	DIN92-22LM22A				
	22	26X1,5	DIN92-22LM26A				
	28	33X2	DIN92-28LM33B				
	35	42X2	DIN92-35LM42B				
	42	48X2	DIN92-42LM48B				

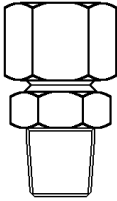
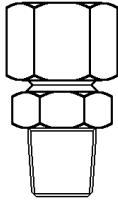
DIRITTO DI ESTREMITA'				Diritto Estremità Metrico Conico Serie L					Diritto Estremità Metrico Conico Serie S
Serie	øTubo	Filetto	Codice		Serie	øTubo	Filetto	Codice	
LL	4	8X1	DIN93-04LLMC08C		S	6	12X1,5	DIN93-06SMC12A	
	6	10X1	DIN93-06LLMC10C			8	14X1,5	DIN93-08SMC14A	
	8	10X1	DIN93-08LLMC10C			10	16X1,5	DIN93-10SMC16A	
L	6	10X1	DIN93-06LMC10C			12	18X1,5	DIN93-12SMC18A	
	8	10X1				12	22X1,5		
	8	12X1,5	DIN93-08LMC12A			14	20X1,5	DIN93-14SMC20A	
	8	18X1,5				16	18X1,5		
	10	14X,15	DIN93-10LMC14A			16	22X1,5	DIN93-16SMC22A	
	10	16X1,5							
	10	18X1,5							
	10	22X1,5							
	12	14X,15							
	12	16X1,5	DIN93-12LMC16A						
	12	18X1,5							
	12	22X1,5							
	15	16X1,5							
	15	18X1,5	DIN93-15LMC18A						
	15	22X1,5							
	18	18X1,5							
	18	22X1,5	DIN93-18LMC22A						

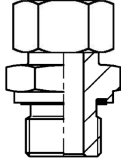
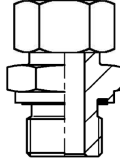
DIRITTO DI ESTREMITA'			 Diritto Estremità SAE Con O-Ring Serie L				 Diritto Estremità SAE Con O-Ring Serie S
Serie	øTubo	Filetto	Codice	Serie	øTubo	Filetto	Codice
L	6	7/16-20	DIN92-06LSAE04	S	6	1/2-20	DIN92-06SSAE05
	6	7/16-20	DIN92-08LSAE04		8	7/16-20	DIN92-08SSAE04
	8	1/2-20	DIN92-08LSAE05		8	1/2-20	DIN92-08SSAE05
	10	7/16-20	DIN92-10LSAE04		10	9/16-18	DIN92-10SSAE06
	10	1/2-20	DIN92-10LSAE05		12	9/16-18	DIN92-12SSAE06
	12	9/16-18	DIN92-12LSAE06		12	3/4-16	DIN92-12SSAE08
	12	3/4-16	DIN92-12LSAE08		14	3/4-16	DIN92-14SSAE08
	12	7/8-14	DIN92-12LSAE10		16	3/4-16	DIN92-16SSAE08
	15	3/4-16	DIN92-15LSAE08		16	7/8-14	DIN92-16SSAE10
	18	3/4-16	DIN92-18LSAE08		20	3/4-16	DIN92-20SSAE08
	18	7/8-14	DIN92-18LSAE10		20	7/8-14	DIN92-20SSAE10
	22	7/8-14	DIN92-22LSAE10		20	1.1/16-12	DIN92-20SSAE12
	22	1.1/16-12	DIN92-22LSAE12		25	1.1/16-12	DIN92-25SSAE12
	22	1.5/16-12	DIN92-22LSAE16		25	1.5/16-12	DIN92-25SSAE16
	28	1.1/16-12	DIN92-28LSAE12		30	1.5/16-12	DIN92-30SSAE16
	28	1.5/16-12	DIN92-28LSAE16		30	1.5/8-12	DIN92-30SSAE20
	35	1.5/16-12	DIN92-35LSAE16		38	1.5/8-12	DIN92-38SSAE20
	35	1.5/8-12	DIN92-35LSAE20		38	1.7/8-12	DIN92-38SSAE24
	42	1.5/8-12	DIN92-42LSAE20				
	42	1.7/8-12	DIN92-42LSAE24				

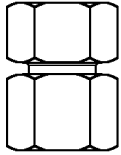
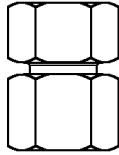
DIRITTO DI ESTREMITA' FEMMINA			 Diritto Estremità Femmina Gas Cilindrico Serie L				 Diritto Estremità Femmina Gas Cilindrico Serie S
Serie	øTubo	Filetto	Codice	Serie	øTubo	Filetto	Codice
L	6	1/8"	DIN147-06LG02	S	6	1/4"	DIN147-06SG04
	8	1/4"	DIN147-08LG04		8	1/4"	DIN147-08SG04
	10	1/4"	DIN147-10LG04		10	3/8"	DIN147-10SG06
	12	3/8"	DIN147-12LG06		12	3/8"	DIN147-12SG06
	15	1/2"	DIN147-15LG08		14	1/2"	DIN147-14SG08
	18	1/2"	DIN147-18LG08		16	1/2"	DIN147-16SG08
	22	3/4"	DIN147-22LG12		20	3/4"	DIN147-20SG12
	28	1"	DIN147-28LG16		25	1"	DIN147-25SG16
	35	1.1/4"	DIN147-35LG20		30	1.1/4"	DIN147-30SG20
	42	1.1/2"	DIN147-42LG24		38	1.1/2"	DIN147-38SG24

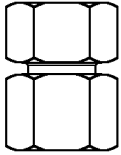
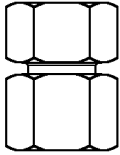
DIRITTO DI ESTREMITA' FEMMINA			 Diritto Estremità Femmina Metrico Cilindrico Serie L				 Diritto Estremità Femmina Metrico Cilindrico Serie S
Serie	øTubo	Filetto	Codice	Serie	øTubo	Filetto	Codice
L	6	10X1	DIN147-06LM10C	S	6	12X1,5	DIN147-06SM12A
	8	12X1,5	DIN147-08LM12A		8	14X1,5	DIN147-08SM14A
	10	14X1,5	DIN147-10LM14A		10	16X1,5	DIN147-10SM16A
	12	16X1,5	DIN147-12LM16A		12	18X1,5	DIN147-12SM18A
	15	18X1,5	DIN147-15LM18A		14	20X1,5	DIN147-14SM20A
	18	22X1,5	DIN147-18LM22A		16	22X1,5	DIN147-16SM22A
	22	26X1,5	DIN147-22LM26A		20	27X2	DIN147-20SM27B
	28	33X2	DIN147-28LM33B		25	33X2	DIN147-25SM33B
	35	42X2	DIN147-35LM42B		30	42X2	DIN147-30SM42B
	42	48X2	DIN147-42LM48B		38	48X2	DIN147-38SM48B

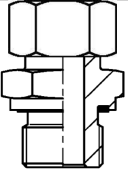
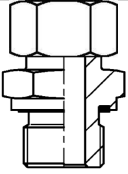
ADATTATORE DI ESTREMITA'			 Adatt. Estremità Gas Cilindrico Guarn. Piana Serrato Serie L				 Adatt. Estremità Gas Cilindrico Guarn. Piana Serrato Serie S
Serie	øTubo	Filetto	Codice	Serie	øTubo	Filetto	Codice
L	6	1/8"	DIN126A06LG02	S	6	1/4"	DIN126A06SG04
	8	1/4"	DIN126A08LG04		8	1/4"	DIN126A08SG04
	10	1/4"	DIN126A10LG04		10	3/8"	DIN126A10SG06
	12	3/8"	DIN126A12LG06		12	3/8"	DIN126A12SG04
	15	1/2"	DIN126A15LG08		14	1/2"	DIN126A14SG08
	18	1/2"	DIN126A18LG08		16	1/2"	DIN126A16SG08
	22	3/4"	DIN126A22LG12		20	3/4"	DIN126A20SG12
	28	1"	DIN126A28LG16		25	1"	DIN126A25SG16
	35	1.1/4"	DIN126A35LG20		30	1.1/4"	DIN126A30SG20
	42	1.1/2"	DIN126A42LG24		38	1.1/2"	DIN126A38SG24

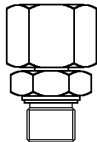
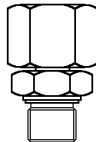
ADATTATORE DI ESTREMITA'			 Adattatore Estremità NPTF Serrato Serie L				 Adattatore Estremità NPTF Serrato Serie S
Serie	øTubo	Filetto	Codice	Serie	øTubo	Filetto	Codice
L	6	1/8"	DIN126A06LN02	S	6	1/4"	DIN126A06SN04
	8	1/4"	DIN126A08LN04		8	1/4"	DIN126A08SN04
	10	1/4"	DIN126A10LN04		10	3/8"	DIN126A10SN06
	12	3/8"	DIN126A12LN06		12	3/8"	DIN126A12SN04
	15	1/2"	DIN126A15LN08		14	1/2"	DIN126A14SN08
	18	1/2"	DIN126A18LN08		16	1/2"	DIN126A16SN08
	22	3/4"	DIN126A22LN12		20	3/4"	DIN126A20SN12
	28	1"	DIN126A28LN16		25	1"	DIN126A25SN16
	35	1.1/4"	DIN126A35LN20		30	1.1/4"	DIN126A30SN20
	42	1.1/2"	DIN126A42LN24		38	1.1/2"	DIN126A38SN24

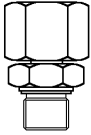
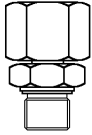
ADATTATORE DI ESTREMITA'			 Adattatore Estremità Metr. Cil. Guarn. Piana Serrato Serie L				 Adattatore Estremità Metr. Cil. Guarn. Piana Serrato Serie S
Serie	øTubo	Filetto	Codice	Serie	øTubo	Filetto	Codice
L	6	10X1	DIN126A06LM10C	S	6	12X1,5	DIN126A06SM12A
	8	12X1,5	DIN126A08LM12A		8	14X1,5	DIN126A08SM14A
	10	14X1,5	DIN126A10LM14A		10	16X1,5	DIN126A10SM16A
	12	16X1,5	DIN126A12LM16A		12	18X1,5	DIN126A12SM18A
	15	18X1,5	DIN126A15LM18A		14	20X1,5	DIN126A14SM20A
	18	22X1,5	DIN126A18LM22A		16	22X1,5	DIN126A16SM22A
	22	26X1,5	DIN126A22LM26A		20	27X2	DIN126A20SM27B
	28	33X2	DIN126A28LM33B		25	33X2	DIN126A25SM33B
	35	42X2	DIN126A35LM42B		30	42X2	DIN126A30SM42B
	42	48X2	DIN126A42LM48B		38	48X2	DIN126A38SM48B

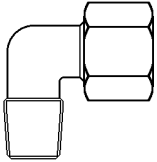
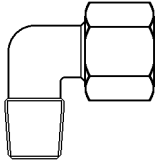
GOMITO DI ESTREMITA'			 Gomito Estremità Gas Conico Serie L				 Gomito Estremità Gas Conico Serie S			
Serie	øTubo	Filetto	Codice	Serie	øTubo	Filetto	Codice			
LL	4	1/8"	DIN94-04LLC02	S	6	1/4"	DIN94-06SC04			
	6	1/8"	DIN94-06LLC02		8	1/4"	DIN94-08SC04			
	8	1/8"	DIN94-08LLC02		10	3/8"	DIN94-10SC06			
L	6	1/8"	DIN94-06LC02		12	3/8"	DIN94-12SC06			
	6	1/4"	DIN94-06LC04		12	1/2"	DIN94-12SC08			
	8	1/8"	DIN94-08LC02		14	3/8"	DIN94-14SC06			
	8	1/4"	DIN94-08LC04		14	1/2"	DIN94-14SC08			
	8	3/8"	DIN94-08LC06		16	3/8"	DIN94-16SC06			
	8	1/2"	DIN94-08LC08		16	1/2"	DIN94-16SC08			
	10	1/8"	DIN94-10LC02		20	1/2"	DIN94-20SC08			
	10	1/4"	DIN94-10LC04		20	3/4"	DIN94-20SC12			
	10	3/8"	DIN94-10LC06		25	3/4"	DIN94-25SC12			
	10	1/2"	DIN94-10LC08		25	1"	DIN94-25SC16			
	12	1/4"	DIN94-12LC04		30	1"	DIN94-30SC16			
	12	1/2"	DIN94-12LC08		30	1.1/4"	DIN94-30SC20			
	12	3/8"	DIN94-12LC06		38	1.1/2"	DIN94-38SC24			
	15	3/8"	DIN94-15LC06							
	15	1/2"	DIN94-15LC08							
	18	1/2"	DIN94-18LC08							
	18	3/4"	DIN94-18LC12							
	22	3/4"	DIN94-22LC12							
	28	1"	DIN94-28LC16							
	35	1.1/4"	DIN94-35LC20							
	42	1.1/2"	DIN94-42LC24							

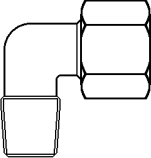
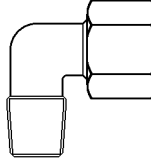
GOMITO DI ESTREMITA'			 Gomito Estremità NPTF Serie L				 Gomito Estremità NPTF Serie L				
Serie	∅Tubo	Filetto	Codice			Serie	∅Tubo	Filetto	Codice		
L	6	1/8"	DIN94-06LN02			S	6	1/4"	DIN94-06SN04		
	6	1/4"	DIN94-06LN04				8	1/4"	DIN94-08SN04		
	8	1/8"	DIN94-08LN02				10	3/8"	DIN94-10SN06		
	8	1/4"	DIN94-08LN04				12	3/8"	DIN94-12SN06		
	8	3/8"	DIN94-08LN06				12	1/2"	DIN94-12SN08		
	8	1/2"	DIN94-08LN08				14	3/8"	DIN94-14SN06		
	10	1/8"	DIN94-10LN02				14	1/2"	DIN94-14SN08		
	10	1/4"	DIN94-10LN04				16	3/8"	DIN94-16SN06		
	10	3/8"	DIN94-10LN06				16	1/2"	DIN94-16SN08		
	10	1/2"	DIN94-10LN08				20	1/2"	DIN94-20SN08		
	12	1/4"	DIN94-12LN04				20	3/4"	DIN94-20SN12		
	12	1/2"	DIN94-12LN08				25	3/4"	DIN94-25SN12		
	12	3/8"	DIN94-12LN06				25	1"	DIN94-25SN16		
	15	3/8"	DIN94-15LN06				30	1"	DIN94-30SN16		
	15	1/2"	DIN94-15LN08				30	1.1/4"	DIN94-30SN20		
	18	1/2"	DIN94-18LN08				38	1.1/2"	DIN94-38SN24		
	18	3/4"	DIN94-18LN12								
	22	3/4"	DIN94-22LN12								
	28	1"	DIN94-28LN16								
	35	1.1/4"	DIN94-35LN20								
	42	1.1/2"	DIN94-42LN24								

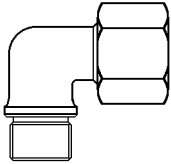
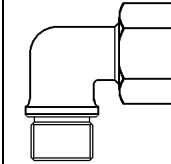
GOMITO DI ESTREMITA'			 Gomito Estremità Gas Cilindrico Serie L				 Gomito Estremità Gas Cilindrico Serie S			
Serie	øTubo	Filetto	Codice		Serie	øTubo	Filetto	Codice		
L	22	3/4"	DIN95-22LG12		S	20	3/4"	DIN95-20SG12		
	28	1"	DIN95-28LG12			25	1"	DIN95-25SG16		
	35	1.1/4"	DIN95-35LG20			30	1.1/4"	DIN95-30SG20		
	42	1.1/2"	DIN95-42LG24			38	1.1/2"	DIN95-38SG24		

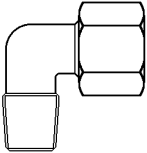
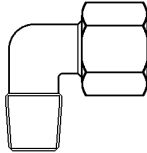
GOMITO DI ESTREMITA'			 Gomito Estremità Metrico Conico Serie L		 Gomito Estremità Metrico Conico Serie S		
Serie	øTubo	Filetto	Codice	Serie	øTubo	Filetto	Codice
LL	4	8X1	DIN94-04LLM08C	S	6	12X1,5	DIN94-06SM12A
	6	10X1	DIN94-06LLM10C		8	14X1,5	DIN94-08SM14A
	8	10X1	DIN94-08LLM10C		10	16X1,5	DIN94-10SM16A
L	6	10X1	DIN94-06LM10C		12	18X1,5	DIN94-12SM18A
	8	12X1,5	DIN94-08LM12A		14	20X1,5	DIN94-14SM20A
	10	14X1,5	DIN94-10LM14A		16	22X1,5	DIN94-16SM22A
	12	16X1,5	DIN94-12LM16A				
	15	18X1,5	DIN94-15LM18A				
	18	22X1,5	DIN94-18LM22A				

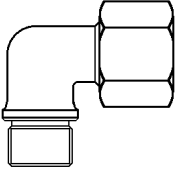
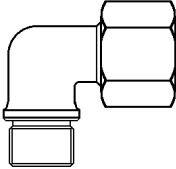
GOMITO DI ESTREMITA'			 Gomito Estremità Metrico Cilindrico Serie L				 Gomito Estremità Metrico Cilindrico Serie S			
Serie	øTubo	Filetto	Codice	Serie	øTubo	Filetto	Codice			
L	22	26X1,5	DIN95-22LM26A	S	20	27X2	DIN95-20SM27B			
	28	33X2	DIN95-28LM33B		25	33X2	DIN95-25SM33B			
	35	42X2	DIN95-35LM42B		30	42X2	DIN95-30SM42B			
	42	48X2	DIN95-42LM48B		38	48X2	DIN95-38SM48B			

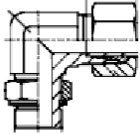
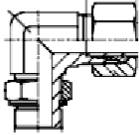
GOMITO ORIENTABILE			 Gomito Estremità Orientabile Gas Cil. Serie L				 Gomito Estremità Orientabile Gas Cil. Serie S
Serie	øTubo	Filetto	Codice	Serie	øTubo	Filetto	Codice
L	6	1/8"	DIN950-06LG02	S	6	1/4"	DIN950-06SG04
	8	1/4"	DIN950-08LG04		8	1/4"	DIN950-08SG04
	10	1/4"	DIN950-10LG04		10	3/8"	DIN950-10SG06
	12	3/8"	DIN950-12LG06		12	3/8"	DIN950-12SG06
	15	1/2"	DIN950-15LG08		14	1/2"	DIN950-14SG08
	18	1/2"	DIN950-18LG08		16	1/2"	DIN950-16SG08
	22	3/4"	DIN950-22LG12		20	3/4"	DIN950-20SG12
	28	1"	DIN950-28LG16		25	1"	DIN950-25SG16
	35	1.1/4"	DIN950-35LG20		30	1.1/4"	DIN950-30SG20
	42	1.1/2"	DIN950-42LG24		38	1.1/2"	DIN950-38SG24

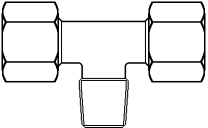
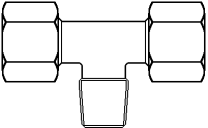
TEE DI ESTREMITA'			 TEE Estremità Centrale Gas Conico Serie L				 TEE Estremità Centrale Gas Conico Serie S
Serie	∅Tubo	Filetto	Codice	Serie	∅Tubo	Filetto	Codice
LL	4	1/8"	DIN96-04LLC02	S	6	1/4"	DIN96-06SC04
	6	1/8"	DIN96-06LLC02		8	1/4"	DIN96-08SC04
	8	1/8"	DIN96-08LLC02		10	3/8"	DIN96-10SC06
L	6	1/8"	DIN96-06LC02		12	3/8"	DIN96-12SC06
	8	1/4"	DIN96-08LC04		14	1/2"	DIN96-14SC08
	10	1/4"	DIN96-10LC04		16	1/2"	DIN96-16SC08
	12	3/8"	DIN96-12LC06		20	3/4"	DIN96-20SC12
	15	1/2"	DIN96-15LC08		25	1"	DIN96-25SC16
	18	1/2"	DIN96-18LC08		30	1.1/4"	DIN96-30SC20
	22	3/4"	DIN96-22LC12		38	1.1/2"	DIN96-38SC24
	28	1"	DIN96-28LC16				
	35	1.1/4"	DIN96-35LC20				
	42	1.1/2"	DIN96-42LC24				

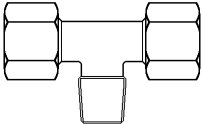
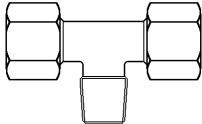
TEE DI ESTREMITA'			 TEE Estremità Centrale NPTF Serie L				 TEE Estremità Centrale NPTF Serie S			
Serie	øTubo	Filetto	Codice		Serie	øTubo	Filetto	Codice		
L	6	1/8"	DIN96-06LN02		S	6	1/4"	DIN96-06SN04		
	8	1/4"	DIN96-08LN04			8	1/4"	DIN96-08SN04		
	10	1/4"	DIN96-10LN04			10	3/8"	DIN96-10SN06		
	12	3/8"	DIN96-12LN06			12	3/8"	DIN96-12SN06		
	15	1/2"	DIN96-15LN08			14	1/2"	DIN96-14SN08		
	18	1/2"	DIN96-18LN08			16	1/2"	DIN96-16SN08		
	22	3/4"	DIN96-22LN12			20	3/4"	DIN96-20SN12		
	28	1"	DIN96-28LN16			25	1"	DIN96-25SN16		
	35	1.1/4"	DIN96-35LN20			30	1.1/4"	DIN96-30SN20		
	42	1.1/2"	DIN96-42LN24			38	1.1/2"	DIN96-38SN24		

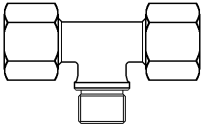
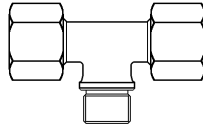
TEE DI ESTREMITA'			 <p>TEE Estremità Centrale Gas Cilindrico Serie L</p>				 <p>TEE Estremità Centrale Gas Cilindrico Serie S</p>
Serie	øTubo	Filetto	Codice	Serie	øTubo	Filetto	Codice
L	22	3/4"	DIN97-22LG12	S	20	3/4"	DIN97-20SG12
	28	1"	DIN97-28LG16		25	1"	DIN97-25SG16
	35	1.1/4"	DIN97-35LG20		30	1.1/4"	DIN97-30SG20
	42	1.1/2"	DIN97-42LG24		38	1.1/2"	DIN97-38SG24

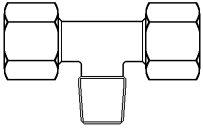
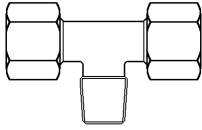
TEE DI ESTREMITA'			 TEE Estremità Centrale Metrico Conico Serie L				 TEE Estremità Centrale Metrico Conico Serie S			
Serie	øTubo	Filetto	Codice		Serie	øTubo	Filetto	Codice		
L	6	10X1	DIN96-06LM10C		S	6	12X1,5	DIN96-06SM12A		
	8	12X1,5	DIN96-08LM12A			8	14X1,5	DIN96-08SM14A		
	10	14X1,5	DIN96-10LM14A			10	16X1,5	DIN96-10SM16A		
	12	16X1,5	DIN96-12LM16A			12	18X1,5	DIN96-12SM18A		
	15	18X1,5	DIN96-15LM18A			14	20X1,5	DIN96-14SM20A		
	18	22X1,5	DIN96-18LM22A			16	22X1,5	DIN96-16SM22A		

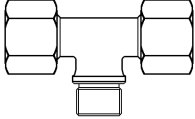
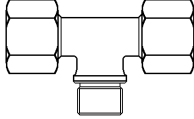
TEE DI ESTREMITA'			 TEE Estremità Centrale Metrico Cilindrico Serie L				 TEE Estremità Centrale Metrico Cilindrico Serie S			
Serie	øTubo	Filetto	Codice		Serie	øTubo	Filetto	Codice		
L	22	26X1,5	DIN97-22LM26A		S	20	27X2	DIN97-20SM27B		
	28	33X2	DIN97-28LM33B			25	33X2	DIN97-25SM33B		
	35	42X2	DIN97-35LM42B			30	42X2	DIN97-30SM42B		
	42	48X2	DIN97-42LM48B			38	48X2	DIN97-38SM48B		

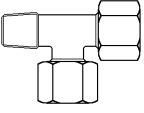
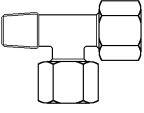
TEE DI ESTREMITA'			TEE Estremità Laterale Gas Conico Serie L				TEE Estremità Laterale Gas Conico Serie S							
														
Serie	øTubo	Filetto	Codice				Serie	øTubo	Filetto	Codice				
L	6	1/8"	DIN127-06LC02				S	6	1/4"	DIN127-06SC04				
	8	1/4"	DIN127-08LC04					8	1/4"	DIN127-08SC04				
	10	1/4"	DIN127-10LC04					10	3/8"	DIN127-10SC06				
	12	3/8"	DIN127-12LC06					12	3/8"	DIN127-12SC06				
	15	1/2"	DIN127-15LC08					14	1/2"	DIN127-14SC08				
	18	1/2"	DIN127-18LC08					16	1/2"	DIN127-16SC08				
	22	3/4"	DIN127-22LC12					20	3/4"	DIN127-20SC12				
	28	1"	DIN127-28LC16					25	1"	DIN127-25SC16				
	35	1.1/4"	DIN127-35LC20					30	1.1/4"	DIN127-30SC20				
	42	1.1/2"	DIN127-42LC24					38	1.1/2"	DIN127-38SC24				

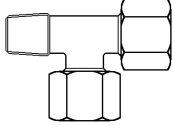
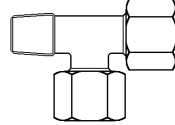
TEE DI ESTREMITA'			 TEE Estremità Laterale NPTF Serie L				 TEE Estremità Laterale NPTF Serie S
Serie	øTubo	Filetto	Codice	Serie	øTubo	Filetto	Codice
L	6	1/8"	DIN127-06LN02	S	6	1/4"	DIN127-06SN04
	8	1/4"	DIN127-08LN04		8	1/4"	DIN127-08SN04
	10	1/4"	DIN127-10LN04		10	3/8"	DIN127-10SN06
	12	3/8"	DIN127-12LN06		12	3/8"	DIN127-12SN06
	15	1/2"	DIN127-15LN08		14	1/2"	DIN127-14SN08
	18	1/2"	DIN127-18LN08		16	1/2"	DIN127-16SN08
	22	3/4"	DIN127-22LN12		20	3/4"	DIN127-20SN12
	28	1"	DIN127-28LN16		25	1"	DIN127-25SN16
	35	1.1/4"	DIN127-35LN20		30	1.1/4"	DIN127-30SN20
	42	1.1/2"	DIN127-42LN24		38	1.1/2"	DIN127-38SN24

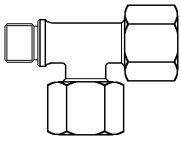
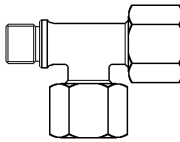
TEE DI ESTREMITA'			 TEE Estremità Laterale Gas Cilindrico Serie L				 TEE Estremità Laterale Gas Cilindrico Serie S
Serie	øTubo	Filetto	Codice	Serie	øTubo	Filetto	Codice
L	22	3/4"	DIN129-22LG12	S	20	3/4"	DIN129-20SG12
	28	1"	DIN129-28LG16		25	1"	DIN129-25SG16
	35	1.1/4"	DIN129-35LG20		30	1.1/4"	DIN129-30SG20
	42	1.1/2"	DIN129-42LG24		38	1.1/2"	DIN129-38SG24

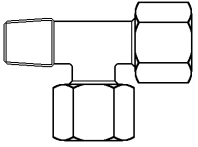
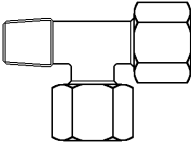
TEE DI ESTREMITA'			 TEE Estremità Laterale Metrico Conico Serie L				 TEE Estremità Laterale Metrico Conico Serie S			
Serie	øTubo	Filetto	Codice		Serie	øTubo	Filetto	Codice		
L	6	10X1	DIN127-06LM10C		S	6	12X1,5	DIN127-06SM12A		
	8	12X1,5	DIN127-08LM12A			8	14X,15	DIN127-08SM14A		
	10	14X1,5	DIN127-10LM14A			10	16X1,5	DIN127-10SM16A		
	12	16X1,5	DIN127-12LM16A			12	18X1,5	DIN127-12SM18A		
	15	18X1,5	DIN127-15LM18A			14	20X1,5	DIN127-14SM20A		
	18	22X1,5	DIN127-18LM22A			16	22X1,5	DIN127-16SM22A		

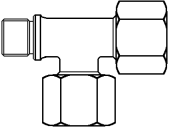
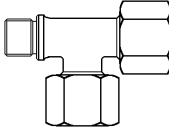
TEE DI ESTREMITA'			 TEE Estremità Laterale Metrico Cilindrico Serie L				 TEE Estremità Laterale Metrico Cilindrico Serie S			
Serie	øTubo	Filetto	Codice		Serie	øTubo	Filetto	Codice		
L	22	26X1,5	DIN129-22LM26A		S	20	27X2	DIN129-20SM27B		
	28	33X2	DIN129-28LM33B			25	33X2	DIN129-25SM33B		
	35	42X2	DIN129-35LM42B			30	42X2	DIN129-30SM42B		
	42	48X2	DIN129-42LM48B			38	48X2	DIN129-38SM48B		

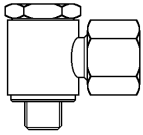
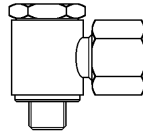
GOMITO ORIENTABILE			 Gomito Orientabile Gas Cilindrico Serie L				 Gomito Orientabile Gas Cilindrico Serie S
Serie	øTubo	Filetto	Codice	Serie	øTubo	Filetto	Codice
LL	4	1/8"	DIN131-06LLG02	S	6	1/4"	DIN131-06SG04
	6	1/8"	DIN131-08LLG02		8	1/4"	DIN131-08SG04
	8	1/8"	DIN131-10LLG02		10	3/8"	DIN131-10SG06
L	6	1/8"	DIN131-06LG02		12	3/8"	DIN131-12SG06
	8	1/4"	DIN131-08LG04		14	1/2"	DIN131-14SG08
	10	1/4"	DIN131-10LG04		16	1/2"	DIN131-16SG08
	12	3/8"	DIN131-12LG06		20	3/4"	DIN131-20SG12
	15	1/2"	DIN131-15LG08		25	1"	DIN131-25SG16
	18	1/2"	DIN131-18LG02		30	1.1/4"	DIN131-30SG20
	22	3/4"	DIN131-22LG12		38	1.1/2"	DIN131-38SG24
	28	1"	DIN131-28LG16				
	35	1.1/4"	DIN131-35LG20				
	42	1.1/2"	DIN131-42LG24				

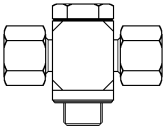
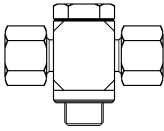
GOMITO ORIENTABILE			 Gomitto Orientabile Doppio Gas Cilindrico Serie L				 Gomitto Orientabile Doppio Gas Cilindrico Serie S
Serie	øTubo	Filetto	Codice	Serie	øTubo	Filetto	Codice
L	6	1/8"	DIN136-06LG02	S	6	1/4"	DIN136-06SG04
	8	1/4"	DIN136-08LG04		8	1/4"	DIN136-08SG04
	10	1/4"	DIN136-10LG04		10	3/8"	DIN136-10SG06
	12	3/8"	DIN136-12LG06		12	3/8"	DIN136-12SG06
	15	1/2"	DIN136-15LG08		14	1/2"	DIN136-14SG08
	18	1/2"	DIN136-18LG08		16	1/2"	DIN136-18SG04
	22	3/4"	DIN136-22LG12		20	3/4"	DIN136-20SG12
	28	1"	DIN136-28LG16		25	1"	DIN136-25SG16
	35	1.1/4"	DIN136-35LG20		30	1.1/4"	DIN136-30SG20
	42	1.1/2"	DIN136-42LG24		38	1.1/2"	DIN136-38SG24

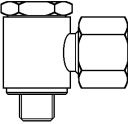
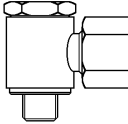
GOMITO ORIENTABILE			 Gomitto Orientabile Metrico Cilindrico Serie L				 Gomitto Orientabile Metrico Cilindrico Serie S
Serie	øTubo	Filetto	Codice	Serie	øTubo	Filetto	Codice
LL	4	8X1	DIN131-04LLM08C	S	6	12X1,5	DIN131-06SM12A
	6	10X1	DIN131-06LLM10C		8	14X1,5	DIN131-08SM14A
	8	10X1	DIN131-08LLM10C		10	16X1,5	DIN131-10SM16A
L	6	10X1	DIN131-06LM10C		12	18X1,5	DIN131-12SM18A
	8	12X1,5	DIN131-08LM12A		14	20X1,5	DIN131-14SM20A
	10	14X1,5	DIN131-10LM14A		16	22X1,5	DIN131-16SM22A
	12	16X1,5	DIN131-12LM16A		20	27X2	DIN131-20SM16A
	15	18X1,5	DIN131-15LM18A		25	33X2	DIN131-25SM27B
	18	22X1,5	DIN131-18LM22A		30	42X2	DIN131-30SM42B
	22	26X1,5	DIN131-22LM26A		38	48X2	DIN131-38SM48B
	28	33X2	DIN131-28LM33B				
	35	42X2	DIN131-35LM42B				
	42	48X2	DIN131-42LM48B				

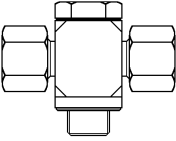
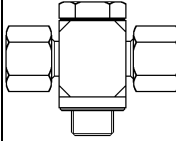
GOMITO ORIENTABILE			 Gomitto Orientabile Doppio Metrico Cilindrico Serie L				 Gomitto Orientabile Doppio Metrico Cilindrico Serie S
Serie	∅Tubo	Filetto	Codice	Serie	∅Tubo	Filetto	Codice
L	6	10X1	DIN136-06LM10C	S	6	12X1,5	DIN136-06SM12A
	8	12X1,5	DIN136-08LM12A		8	14X1,5	DIN136-08SM14A
	10	14X1,5	DIN136-10LM14A		10	16X1,5	DIN136-10SM16A
	12	16X1,5	DIN136-12LM16A		12	18X1,5	DIN136-12SM18A
	15	18X1,5	DIN136-15LM18A		14	20X1,5	DIN136-14SM20A
	18	22X1,5	DIN136-18LM22A		16	22X1,5	DIN136-16SM22A
	22	26X1,5	DIN136-22LM26A		20	27X2	DIN136-20SM27B
	28	33X2	DIN136-28LM33B		25	33X2	DIN136-25SM33B
	35	42X2	DIN136-35LM42B		30	42X2	DIN136-30SM42B
	42	48X2	DIN136-42LM48B		38	48X2	DIN136-38SM48B

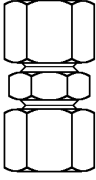
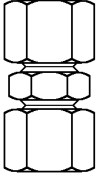
CONNESSIONE TUBO-TUBO		 Intermedio Dritto Serie L		 Intermedio Dritto Serie S	
Serie	øTubo	Codice	Serie	øTubo	Codice
LL	4	DIN98-04LL	S	6	DIN98-06S
	6	DIN98-06LL		8	DIN98-08S
	8	DIN98-08LL		10	DIN98-10S
L	6	DIN98-06L		12	DIN98-12S
	8	DIN98-08L		14	DIN98-14S
	10	DIN98-10L		16	DIN98-16S
	12	DIN98-12L		20	DIN98-20S
	15	DIN98-15L		25	DIN98-25S
	18	DIN98-18L		30	DIN98-30S
	22	DIN98-22L		38	DIN98-38S
	28	DIN98-28L			
	35	DIN98-35L			
	42	DIN98-42L			

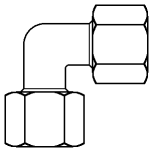
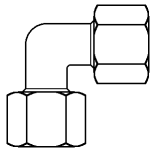
CONNESSIONE TUBO-TUBO		 Intermedio a Gomito Serie L		 Intermedio a Gomito Serie S	
Serie	øTubo	Codice	Serie	øTubo	Codice
LL	4	DIN99-04LL	S	6	DIN99-06S
	6	DIN99-06LL		8	DIN99-08S
	8	DIN99-08LL		10	DIN99-10S
L	6	DIN99-06L		12	DIN99-12S
	8	DIN99-08L		14	DIN99-14S
	10	DIN99-10L		16	DIN99-16S
	12	DIN99-12L		20	DIN99-20S
	15	DIN99-15L		25	DIN99-25S
	18	DIN99-18L		30	DIN99-30S
	22	DIN99-22L		38	DIN99-38S
	28	DIN99-28L			
	35	DIN99-35L			
	42	DIN99-42L			

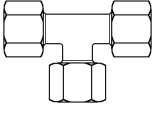
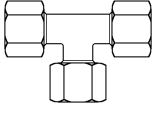
CONNESSIONE TUBO-TUBO		 Intermedio a TEE Serie L		 Intermedio a TEE Serie S	
Serie	øTubo	Codice	Serie	øTubo	Codice
LL	4	DIN100-04LL	S	6	DIN100-06S
	6	DIN100-06LL		8	DIN100-08S
	8	DIN100-08LL		10	DIN100-10S
L	6	DIN100-06L		12	DIN100-12S
	8	DIN100-08L		14	DIN100-14S
	10	DIN100-10L		16	DIN100-16S
	12	DIN100-12L		20	DIN100-20S
	15	DIN100-15L		25	DIN100-25S
	18	DIN100-18L		30	DIN100-30S
	22	DIN100-22L		38	DIN100-38S
	28	DIN100-28L			
	35	DIN100-35L			
	42	DIN100-42L			

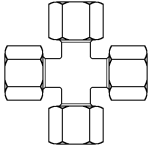
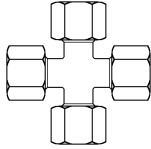
CONNESSIONE TUBO-TUBO		 Intermedio a Croce Serie L		 Intermedio a Croce Serie S	
Serie	øTubo	Codice	Serie	øTubo	Codice
LL	4	DIN101-04LL	S	6	DIN101-06S
	6	DIN101-06LL		8	DIN101-08S
	8	DIN101-08LL		10	DIN101-10S
L	6	DIN101-06L		12	DIN101-12S
	8	DIN101-08L		14	DIN101-14S
	10	DIN101-10L		16	DIN101-16S
	12	DIN101-12L		20	DIN101-20S
	15	DIN101-15L		25	DIN101-25S
	18	DIN101-18L		30	DIN101-30S
	22	DIN101-22L		38	DIN101-38S
	28	DIN101-28L			
	35	DIN101-35L			
	42	DIN101-42L			

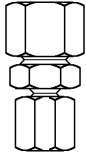
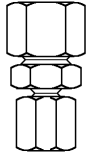
CONNESSIONE TUBO-TUBO			 Intermedio Dritto Ridotto Serie L				 Intermedio Dritto Ridotto Serie S
Serie	øTubo	øTubo	Codice	Serie	øTubo	øTubo	Codice
LL	6	4	DIN98R-06/04LL	S	8	6	DIN98R-08/06S
	8	4	DIN98R-08/04LL		10	6	DIN98R-10/06S
	8	6	DIN98R-08/06LL		10	8	DIN98R-10/08S
L	8	6	DIN98R-08/06LL		12	6	DIN98R-12/06S
	10	6	DIN98R-10/06L		12	8	DIN98R-12/08S
	10	8	DIN98R-10/08L		12	10	DIN98R-12/10S
	12	6	DIN98R-12/06L		14	10	DIN98R-14/10S
	12	8	DIN98R-12/08L		14	12	DIN98R-14/12S
	12	10	DIN98R-12/10L		16	12	DIN98R-16/12S
	15	10	DIN98R-15/10L		16	14	DIN98R-16/14S
	15	12	DIN98R-15/12L		20	10	DIN98R-20/10S
	18	10	DIN98R-18/10L		20	12	DIN98R-20/12S
	18	12	DIN98R-18/12L		20	16	DIN98R-20/16S
	18	15	DIN98R-18/15L		25	16	DIN98R-25/16S
	22	12	DIN98R-22/12L		25	20	DIN98R-25/20S
	22	15	DIN98R-22/15L		30	20	DIN98R-30/20S
	22	18	DIN98R-22/18L		30	25	DIN98R-30/25S
	28	18	DIN98R-28/18L		38	30	DIN98R-38/30S
	28	22	DIN98R-28/22L				
	35	22	DIN98R-35/22L				
	35	28	DIN98R-35/28L				

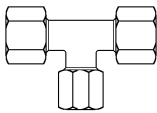
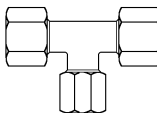
CONNESSIONE TUBO-TUBO				 TEE Intermedio Ridotto Serie L					 TEE Intermedio Ridotto Serie S
Serie	∅Tubo	∅Tubo	∅Tubo	Codice	Serie	∅Tubo	∅Tubo	∅Tubo	Codice
LL	4	8	4	DIN100R-04/08/04LL	S	10	6	10	DIN100R-10/06/10S
	6	4	6	DIN100R-06/04/06LL		12	8	8	DIN100R-12/08/08S
L	6	8	6	DIN100R-06/08/06L		12	8	12	DIN100R-12/08/12S
	8	6	8	DIN100R-08/06/08L		12	10	12	DIN100R-12/10/12S
	6	10	6	DIN100R-06/10/06L		12	16	12	DIN100R-12/16/12S
	8	10	8	DIN100R-08/10/08L		16	6	16	DIN100R-16/06/16S
	10	6	10	DIN100R-10/06/10L		16	8	16	DIN100R-16/08/16S
	10	8	10	DIN100R-10/08/10L		16	10	16	DIN100R-16/10/16S
	10	10	6	DIN100R-10/10/06L		16	12	16	DIN100R-16/12/16S
	8	12	8	DIN100R-08/12/08L		16	20	16	DIN100R-16/20/16S
	12	6	12	DIN100R-12/06/12L		20	10	20	DIN100R-20/10/20S
	12	8	8	DIN100R-12/08/08L		20	12	20	DIN100R-20/12/20S
	12	8	12	DIN100R-12/08/12L		20	16	20	DIN100R-20/16/20S
	12	10	10	DIN100R-12/10/10L		20	25	20	DIN100R-20/25/20S
	12	10	12	DIN100R-12/10/12L		25	16	25	DIN100R-25/16/25S
	12	12	10	DIN100R-12/12/10L		25	20	25	DIN100R-25/20/25S
	10	15	10	DIN100R-10/15/10L		25	30	25	DIN100R-25/30/25S
	12	15	12	DIN100R-12/15/12L					
	15	6	15	DIN100R-15/06/15L					
	15	10	15	DIN100R-15/10/15L					
	15	12	12	DIN100R-15/12/12L					
	15	12	15	DIN100R-15/12/15L					
	15	15	12	DIN100R-15/15/12L					
	12	18	12	DIN100R-12/18/12L					
	18	10	10	DIN100R-18/10/10L					
	18	10	18	DIN100R-18/10/18L					
	18	12	18	DIN100R-18/12/18L					
	18	15	18	DIN100R-18/15/18L					
	18	18	10	DIN100R-18/18/10L					
	22	10	22	DIN100R-22/10/22L					
	22	12	22	DIN100R-22/12/22L					
	22	15	15	DIN100R-22/15/15L					
	22	15	22	DIN100R-22/15/22L					
	22	18	18	DIN100R-22/18/18L					
	22	18	22	DIN100R-22/18/22L					
	22	22	18	DIN100R-22/22/18L					
	28	10	28	DIN100R-28/10/28L					
	28	12	28	DIN100R-28/12/28L					

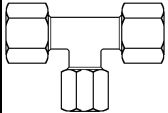
CONNESSIONE TUBO-TUBO				 TEE Intermedio Ridotto Serie L					
Serie	øTubo	øTubo	øTubo	Codice	Serie	øTubo	øTubo	øTubo	Codice
L	28	12	28	DIN100R-28/12/28L					
	28	15	28	DIN100R-28/15/28L					
	28	18	28	DIN100R-28/18/28L					
	28	22	22	DIN100R-28/22/22L					
	28	22	28	DIN100R-28/22/28L					

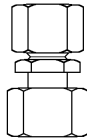
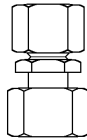
CONNESSIONE TUBO-TUBO			 Riduzione a Codolo Dritto Serie L		 Riduzione a Codolo Dritto Serie S		
Serie	øTubo	øTubo	Codice	Serie	øTubo	øTubo	Codice
L	8	6	DIN132A08/06L	S	8	6	DIN132A08/06S
	10	6	DIN132A10/06L		10	6	DIN132A10/06S
	12	6	DIN132A12/06L		12	6	DIN132A12/06S
	15	6	DIN132A15/06L		14	6	DIN132A14/06S
	18	6	DIN132A18/06L		16	6	DIN132A16/06S
	22	6	DIN132A22/06L		20	6	DIN132A20/06S
	28	6	DIN132A28/06L		25	6	DIN132A25/06S
	35	6	DIN132A35/06L		30	6	DIN132A30/06S
	42	6	DIN132A42/06L		38	6	DIN132A38/06S
	10	8	DIN132A10/08L		10	8	DIN132A10/08S
	12	8	DIN132A12/08L		12	8	DIN132A12/08S
	15	8	DIN132A15/08L		14	8	DIN132A14/08S
	18	8	DIN132A18/08L		16	8	DIN132A16/08S
	22	8	DIN132A22/08L		20	8	DIN132A20/08S
	28	8	DIN132A28/08L		25	8	DIN132A25/08S
	35	8	DIN132A35/08L		30	8	DIN132A30/08S
	42	8	DIN132A42/08L		38	8	DIN132A38/08S
	12	10	DIN132A12/10L		12	10	DIN132A12/10S
	15	10	DIN132A15/10L		14	10	DIN132A14/10S
	18	10	DIN132A18/10L		16	10	DIN132A16/10S
	22	10	DIN132A22/10L		20	10	DIN132A20/10S
	28	10	DIN132A2/10L		25	10	DIN132A25/10S
	35	10	DIN132A35/10L		30	10	DIN132A30/10S
	42	10	DIN132A42/10L		38	10	DIN132A38/10S
	15	12	DIN132A15/12L		14	12	DIN132A14/12S
	18	12	DIN132A18/12L		16	12	DIN132A16/12S
	22	12	DIN132A22/12L		20	12	DIN132A20/12S
	28	12	DIN132A28/12L		25	12	DIN132A25/12S
	35	12	DIN132A35/12L		30	12	DIN132A35/12S
	42	12	DIN132A42/12L		38	12	DIN132A38/12S
	18	15	DIN132A18/15L		16	14	DIN132A16/14S
	22	15	DIN132A22/15L		20	14	DIN132A20/14S
	28	15	DIN132A28/15L		25	14	DIN132A25/14S
	35	15	DIN132A35/15L		30	14	DIN132A30/14S
	42	15	DIN132A42/15L		38	14	DIN132A38/14S
	22	18	DIN132A22/18L		20	16	DIN132A20/16S
	28	18	DIN132A28/18L		25	16	DIN132A25/16S
	35	18	DIN132A35/18L		30	16	DIN132A30/16S

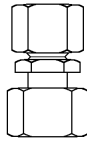
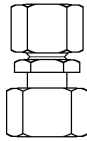
CONNESSIONE TUBO-TUBO			 Riduzione a Codolo Dritto Serie L		 Riduzione a Codolo Dritto Serie S		
Serie	øTubo	øTubo	Codice	Serie	øTubo	øTubo	Codice
L	35	18	DIN132A35/18L	S	30	16	DIN132A30/16S
	42	18	DIN132A42/18L		38	16	DIN132A38/16S
	28	22	DIN132A28/22L		25	20	DIN132A25/20S
	35	22	DIN132A35/22L		30	20	DIN132A30/20S
	42	22	DIN132A42/22L		38	20	DIN132A38/20S
	35	28	DIN132A35/28L		30	25	DIN132A30/25S
	42	28	DIN132A42/28L		38	25	DIN132A38/25S
	42	35	DIN132A42/35L		38	30	DIN132A38/30S

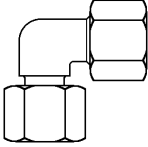
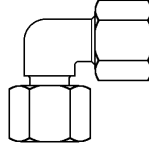
CONNESSIONE ORIENTABILE		 Racc. Orientabile a Gomito Premontato Serie L		 Racc. Orientabile a Gomito Premontato Serie S	
Serie	øTubo	Codice	Serie	øTubo	Codice
L	6	DIN119-06L	S	6	DIN119-06S
	8	DIN119-08L		8	DIN119-08S
	10	DIN119-10L		10	DIN119-10S
	12	DIN119-12L		12	DIN119-12S
	15	DIN119-15L		14	DIN119-14S
	18	DIN119-18L		16	DIN119-16S
	22	DIN119-22L		20	DIN119-20S
	28	DIN119-28L		25	DIN119-25S
	35	DIN119-35L		30	DIN119-30S
	42	DIN119-42L		38	DIN119-38S

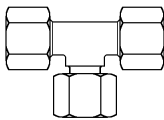
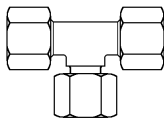
CONNESSIONE ORIENTABILE		 Racc. Orientabile TEE Centrale Serie L		 Racc. Orientabile TEE Centrale Serie S			
Serie	øTubo	Codice		Serie	øTubo	Codice	
L	6	DIN120-06L		S	6	DIN120-06S	
	8	DIN120-08L			8	DIN120-08S	
	10	DIN120-10L			10	DIN120-10S	
	12	DIN120-12L			12	DIN120-12S	
	15	DIN120-15L			14	DIN120-14S	
	18	DIN120-18L			16	DIN120-16S	
	22	DIN120-22L			20	DIN120-20S	
	28	DIN120-28L			25	DIN120-25S	
	35	DIN120-35L			30	DIN120-30S	
	42	DIN120-42L			38	DIN120-38S	

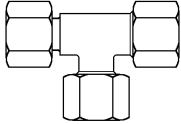
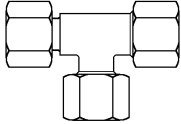
CONNESSIONE ORIENTABILE		 Racc. Orientabile TEE Laterale Serie L		 Racc. Orientabile TEE Laterale Serie S	
Serie	øTubo	Codice	Serie	øTubo	Codice
L	6	DIN121-06L	S	6	DIN121-06S
	8	DIN121-08L		8	DIN121-08S
	10	DIN121-10L		10	DIN121-10S
	12	DIN121-12L		12	DIN121-12S
	15	DIN121-15L		14	DIN121-14S
	18	DIN121-18L		16	DIN121-16S
	22	DIN121-22L		20	DIN121-20S
	28	DIN121-28L		25	DIN121-25S
	35	DIN121-35L		30	DIN121-30S
	42	DIN121-42L		38	DIN121-38S

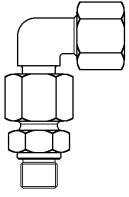
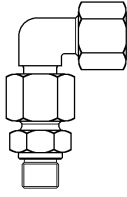
RACCORDO ORIENTABILE			 Racc. Orientabile Gomito Combinato Serie L				 Racc. Orientabile Gomito Combinato Serie S
Serie	øTubo	Filetto	Codice	Serie	øTubo	Filetto	Codice
L	6	1/8"	DIN114-06LG02	S	6	1/4"	DIN114-06SG04
	8	1/4"	DIN114-08LG04		8	1/4"	DIN114-08SG04
	10	1/4"	DIN114-10LG04		10	3/8"	DIN114-10SG06
	12	3/8"	DIN114-12LG06		12	3/8"	DIN114-12SG06
	15	1/2"	DIN114-15LG08		14	1/2"	DIN114-14SG08
	18	1/2"	DIN114-18LG08		16	1/2"	DIN114-16SG08
	22	3/4"	DIN114-22LG12		20	3/4"	DIN114-20SG12
	28	1"	DIN114-28LG16		25	1"	DIN114-25SG16
	35	1.1/4"	DIN114-35LG20		30	1.1/4"	DIN114-30SG20
	42	1.1/2"	DIN114-42LG24		38	1.1/2"	DIN114-38SG24

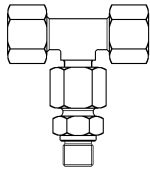
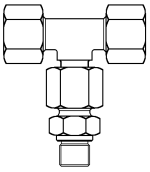
RACCORDO ORIENTABILE			 Racc. Orientabile TEE Centrale Combinato Serie L				 Racc. Orientabile TEE Centrale Combinato Serie S
Serie	øTubo	Filetto	Codice	Serie	øTubo	Filetto	Codice
L	6	1/8"	DIN115-06LG02	S	6	1/4"	DIN115-06SG04
	8	1/4"	DIN115-08LG04		8	1/4"	DIN115-08SG04
	10	1/4"	DIN115-10LG04		10	3/8"	DIN115-10SG06
	12	3/8"	DIN115-12LG06		12	3/8"	DIN115-12SG06
	15	1/2"	DIN115-15LG08		14	1/2"	DIN115-14SG08
	18	1/2"	DIN115-18LG08		16	1/2"	DIN115-16SG08
	22	3/4"	DIN115-22LG12		20	3/4"	DIN115-20SG12
	28	1"	DIN115-28LG16		25	1"	DIN115-25SG16
	35	1.1/4"	DIN115-35LG20		30	1.1/4"	DIN115-30SG20
	42	1.1/2"	DIN115-42LG24		38	1.1/2"	DIN115-38SG24

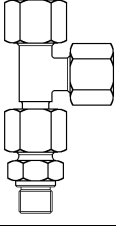
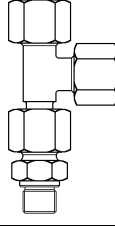
RACCORDO ORIENTABILE			 Racc. Orientabile TEE Laterale Serie L				 Racc. Orientabile TEE Laterale Serie S
Serie	øTubo	Filetto	Codice	Serie	øTubo	Filetto	Codice
L	6	1/8"	DIN116-06LG02	S	6	1/4"	DIN116-06SG04
	8	1/4"	DIN116-08LG04		8	1/4"	DIN116-08SG04
	10	1/4"	DIN116-10LG04		10	3/8"	DIN116-10SG06
	12	3/8"	DIN116-12LG06		12	3/8"	DIN116-12SG06
	15	1/2"	DIN116-15LG08		14	1/2"	DIN116-14SG08
	18	1/2"	DIN116-18LG08		16	1/2"	DIN116-16SG08
	22	3/4"	DIN116-22LG12		20	3/4"	DIN116-20SG12
	28	1"	DIN116-28LG16		25	1"	DIN116-25SG16
	35	1.1/4"	DIN116-35LG20		30	1.1/4"	DIN116-30SG20
	42	1.1/2"	DIN116-42LG24		38	1.1/2"	DIN116-38SG24

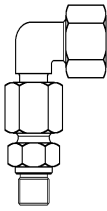
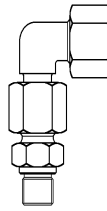
RACCORDO ORIENTABILE			 Racc. Orientabile Gomito Combinato Serie L				 Racc. Orientabile Gomito Combinato Serie S
Serie	øTubo	Filetto	Codice	Serie	øTubo	Filetto	Codice
L	6	10X1	DIN114-06LM10C	S	6	12X1,5	DIN114-06SM12A
	8	12X1,5	DIN114-08LM12A		8	14X1,5	DIN114-08SM14A
	10	14X1,5	DIN114-10LM14A		10	16X1,5	DIN114-10SM16A
	12	16X1,5	DIN114-12LM16A		12	18X1,5	DIN114-12SM18A
	15	18X1,5	DIN114-15LM18A		14	20X1,5	DIN114-14SM20A
	18	22X1,5	DIN114-18LM22A		16	22X1,5	DIN114-16SM22A
	22	26X1,5	DIN114-22LM26A		20	27X2	DIN114-20SM27B
	28	33X2	DIN114-28LM33B		25	33X2	DIN114-25SM33B
	35	42X2	DIN114-35LM42B		30	42X2	DIN114-30SM42B
	42	48X2	DIN114-42LM48B		38	48X2	DIN114-38SM48B

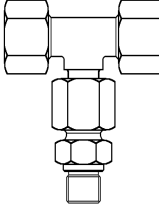
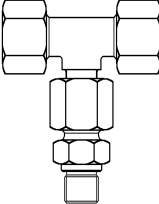

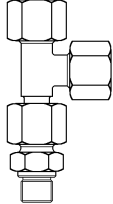
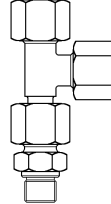
RACCORDO ORIENTABILE			 Racc. Orientabile TEE Centrale Combinato Serie L				 Racc. Orientabile TEE Centrale Combinato Serie S
Serie	øTubo	Filetto	Codice	Serie	øTubo	Filetto	Codice
L	6	10X1	DIN115-06LM10C	S	6	12X1,5	DIN115-06SM12A
	8	12X1,5	DIN115-08LM12A		8	14X1,5	DIN115-08SM14A
	10	14X1,5	DIN115-10LM14A		10	16X1,5	DIN115-10SM16A
	12	16X1,5	DIN115-12LM16A		12	18X1,5	DIN115-12SM18A
	15	18X1,5	DIN115-15LM18A		14	20X1,5	DIN115-14SM20A
	18	22X1,5	DIN115-18LM22A		16	22X1,5	DIN115-16SM22A
	22	26X1,5	DIN115-22LM26A		20	27X2	DIN115-20SM27B
	28	33X2	DIN115-28LM33B		25	33X2	DIN115-25SM33B
	35	42X2	DIN115-35LM42B		30	42X2	DIN115-30SM42B
	42	48X2	DIN115-42LM48B		38	48X2	DIN115-38SM48B

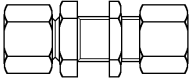
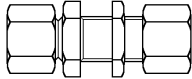

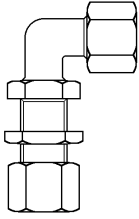
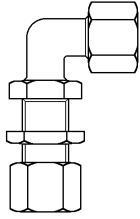
RACCORDO ORIENTABILE			 <p>Racc. Orient. TEE Laterale Combinato Metrico Serie L</p>				 <p>Racc. Orient. TEE Laterale Combinato Metrico Serie S</p>
Serie	øTubo	Filetto		Codice	Serie	øTubo	
L	6	10X1	DIN116-06LM10C	S	6	12X1,5	DIN116-06SM12A
	8	12X1,5	DIN116-08LM12A		8	14X1,5	DIN116-08SM14A
	10	14X1,5	DIN116-10LM14A		10	16X1,5	DIN116-10SM16A
	12	16X1,5	DIN116-12LM16A		12	18X1,5	DIN116-12SM18A
	15	18X1,5	DIN116-15LM18A		14	20X1,5	DIN116-14SM20A
	18	22X1,5	DIN116-18LM22A		16	22X1,5	DIN116-16SM22A
	22	26X1,5	DIN116-22LM26A		20	27X2	DIN116-20SM27B
	28	33X2	DIN116-28LM33B		25	33X2	DIN116-25SM33B
	35	42X2	DIN116-35LM42B		30	42X2	DIN116-30SM42B
	42	48X2	DIN116-42LM48B		38	48X2	DIN116-38SM48B

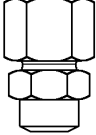
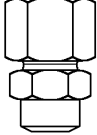
CONNESSIONE TUBO-TUBO		 Racc. di Attraversamento Dritto Serie L		 Racc. di Attraversamento Dritto Serie S			
Serie	∅Tubo	Codice		Serie	∅Tubo	Codice	
L	6	DIN102-06L		S	6	DIN102-06S	
	8	DIN102-08L			8	DIN102-08S	
	10	DIN102-10L			10	DIN102-10S	
	12	DIN102-12L			12	DIN102-12S	
	15	DIN102-15L			14	DIN102-14S	
	18	DIN102-18L			16	DIN102-16S	
	22	DIN102-22L			20	DIN102-20S	
	28	DIN102-28L			25	DIN102-25S	
	35	DIN102-35L			30	DIN102-30S	
	42	DIN102-42L			38	DIN102-38S	

CONNESSIONE TUBO-TUBO		 Racc. di Attraversamento Gomito Serie L		 Racc. di Attraversamento Gomito Serie L	
Serie	øTubo	Codice	Serie	øTubo	Codice
L	6	DIN118-06L	S	6	DIN118-06S
	8	DIN118-08L		8	DIN118-08S
	10	DIN118-10L		10	DIN118-10S
	12	DIN118-12L		12	DIN118-12S
	15	DIN118-15L		14	DIN118-14S
	18	DIN118-18L		16	DIN118-16S
	22	DIN118-22L		20	DIN118-20S
	28	DIN118-28L		25	DIN118-25S
	35	DIN118-35L		30	DIN118-30S
	42	DIN118-42L		38	DIN118-38S

CONNESSIONE TUBO-TUBO		 Diritto Estremità a Saldare Serie L		 Diritto Estremità a Saldare Serie S	
Serie	øTubo	Codice	Serie	øTubo	Codice
L	6	DIN91-06L	S	6	DIN91-06S
	8	DIN91-08L		8	DIN91-08S
	10	DIN91-10L		10	DIN91-10S
	12	DIN91-12L		12	DIN91-12S
	15	DIN91-15L		14	DIN91-14S
	18	DIN91-18L		16	DIN91-16S
	22	DIN91-22L		20	DIN91-20S
	28	DIN91-28L		25	DIN91-25S
	35	DIN91-35L		30	DIN91-30S
	42	DIN91-42L		38	DIN91-38S

CONNESSIONE TUBO-TUBO		 Passante Paratia a Saldare Serie L		 Passante Paratia a Saldare Serie S			
Serie	øTubo	Codice		Serie	øTubo	Codice	
L	6	DIN117-06L		S	6	DIN117-06S	
	8	DIN117-08L			8	DIN117-08S	
	10	DIN117-10L			10	DIN117-10S	
	12	DIN117-12L			12	DIN117-12S	
	15	DIN117-15L			14	DIN117-14S	
	18	DIN117-18L			16	DIN117-16S	
	22	DIN117-22L			20	DIN117-20S	
	28	DIN117-28L			25	DIN117-25S	
	35	DIN117-35L			30	DIN117-30S	
	42	DIN117-42L			38	DIN117-38S	

TAPPO CAP		 Tappo Connessione Tubo Con O-Ring Serie L		 Tappo Connessione Tubo Con O-Ring Serie S	
Serie	øTubo	Codice	Serie	øTubo	Codice
L	6	DIN324-06LS	S	6	DIN324-06LS
	8	DIN324-08LS		8	DIN324-08LS
	10	DIN324-10LS		10	DIN324-10LS
	12	DIN324-12LS		12	DIN324-12LS
	15	DIN324-15L		14	DIN324-14S
	18	DIN324-18L		16	DIN324-16S
	22	DIN324-22L		20	DIN324-20S
	28	DIN324-28L		25	DIN324-25S
	35	DIN324-35L		30	DIN324-30S
	42	DIN324-42L		38	DIN324-38S

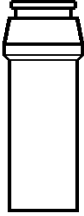
RACCORDI A SALDARE		 <p>Codolo a Saldare con O-Ring</p>
Serie	øTubo	Codice
S	6	DIN299B-06SA
	8	DIN299B-08SA
	10	DIN299B-10SB
	12	DIN299B-12SC
	14	DIN299B-14SD
	16	DIN299B-16SD
	20	DIN299B-20SE
	25	DIN299B-25SE
	25	DIN299B-25SF
	30	DIN299B-30SE
	30	DIN299B-30SF
	30	DIN299B-30SG
	38	DIN299B-38SF
	38	DIN299B-38SG
	38	DIN299B-38SH

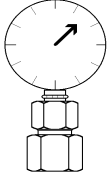
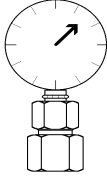
RACCORDO MANOMETRO			 Serie L		 Serie S		
Serie	øTubo	Filetto	Codice	Serie	øTubo	Filetto	Codice
L	6	1/4"	DIN103-06LG	S	6	1/2"	DIN103-06SG
	8	1/4"	DIN103-08LG		8	1/2"	DIN103-08SG
	10	1/4"	DIN103-10LG		10	1/2"	DIN103-10SG
	12	1/4"	DIN103-12LG		12	1/2"	DIN103-12SG

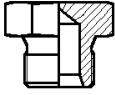
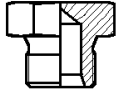
TAPPO			 Tappo Maschio 24° Serie L				 Tappo Maschio 24° Serie S			
Serie	øTubo	Filetto	Codice	Serie	øTubo	Filetto	Codice			
L	6	12X1,5	DIN296-06L	S	6	14X1,5	DIN296-06S			
	8	14X1,5	DIN296-08L		8	16X1,5	DIN296-08S			
	10	16X1,5	DIN296-10L		10	18X1,5	DIN296-10S			
	12	18X1,5	DIN296-12L		12	20X1,5	DIN296-12S			
	15	22X1,5	DIN296-15L		14	22X1,5	DIN296-14S			
	18	26X1,5	DIN296-18L		16	24X1,5	DIN296-16S			
	22	30X2	DIN296-22L		20	30X2	DIN296-20S			
	28	36X2	DIN296-28L		25	36X2	DIN296-25S			
	35	45X2	DIN296-35L		30	42X2	DIN296-30S			
	42	52X2	DIN296-42L		38	52X2	DIN296-38S			

COLLARI SERIE STANDAR						Collare Polipropilene Tipo C1	
Dimensioni				Viti TCEI	ø Est. Tubo	Codice	
B	C	D	H				
28	28	20,4	0,6	6x22	6	C1-06	
					8	C1-08	
					10	C1-10	
					12	C1-12	
					1/4"	C1-1/4"	

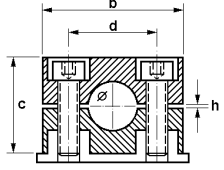
COLLARI SERIE STANDAR					 Collare Polipropilene Tipo C	
Dimensioni				Viti TCEI	ø Est. Tubo	Codice
B	C	D	H			
37	28	20	0,6	6x22	6	C2-06
					8	C2-08
					10	C2-10
					12	C2-12
					1/4"	C2-1/4
43	33	26	0,8	6X28	14	C3-14
					15	C3-15
					16	C3-16
					18	C3-18
					1/4"	C3-1/4
					3/8"	C3-3/8
50	36	33	0,8	6X30	20	C4-20
					22	C4-22
					23	C4-23
					25	C4-25
					1/2"	C4-1/2
57	44	40	1	6X40	28	C5-28
					30	C5-30
					32	C5-32
					3/4"	C5-3/4
69,5	57	52	1	6X50	32	C6-32
					35	C6-35
					38	C6-38
					40	C6-40
					42	C6-42
					45	C6-45
					1"	C6-1
					1.1/4"	C6-1.1/4

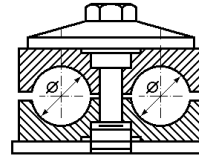
COLLARI SERIE DOPPIA

Collare Polipropilene Tipo CF

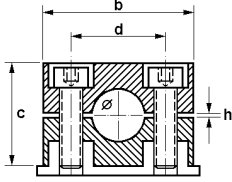
Dimensioni						Viti TCEI	ø Est. Tubo	Codice
B	C	D	E	F	I			
36	27	20	37	0,6	4	6X35	6	CF1-06
							8	CF1-08
							10	CF1-10
							12	CF1-12
54	26	29	55	0,8	4	8X35	14	CF2-14
							15	CF2-15
							16	CF2-16
							18	CF2-18
							1/4"	CF2-1/4
							3/8"	CF2-3/8
67	37	36	70	1	4	8X45	20	CF3-20
							22	CF3-22
							23	CF3-23
							25	CF3-25
							1/2"	CF3-1/2
81	42	45	85	1	4	8X50	26	CF4-26
							28	CF4-28
							30	CF4-30
							3/4"	CF4-3/4
106	53	56	85	110	1,2	8X65	32	CF5-32
							33	CF5-33
							35	CF5-35
							38	CF5-38
							40	CF5-40
							42	CF5-42
							1"	CF5-1
							1.1/4"	CF5-1,1/4

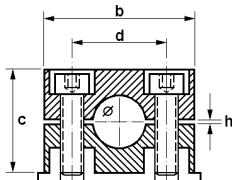
COLLARI SERIE PESANTE					 Collare Polipropilene Tipo CP		
Dimensioni					Viti TCEI	ø Est. Tubo	Codice
B	C	D	G	H			
57	33	33	70	1	10X45	6	CP1-06
						8	CP1-08
						10	CP1-10
						12	CP1-12
						14	CP1-14
						15	CP1-15
						16	CP1-16
						18	CP1-18
						1/4"	CP1-1/4
						3/8"	CP1-3/8
69	49	45	87	1	10X60	20	CP2-20
						22	CP2-22
						25	CP2-25
						28	CP2-28
						1/2"	CP2-1/2
						3/4"	CP2-3/4

COLLARI SERIE PESANTE						 Collare Polipropilene Tipo CP	
Dimensioni					Viti TCEI	ø Est. Tubo	Codice
B	C	D	G	H			
84	60	60	105	1,2	10X70	30	CP3-06
						32	CP3-32
						35	CP3-35
						36	CP3-36
						38	CP3-38
						40	CP3-40
						42	CP3-42
						1"	CP3-1
						1.1/4"	CP3-1.1/4"
84	60	60	105	1,2	10X70	38	CP4-38
						40	CP4-40
						42	CP4-42
						48	CP4-48
						50	CP4-50
						56	CP4-56
						60	CP4-60
						65	CP4-65
						70	CP4-70
						1.1/4"	CP4-1.1/4"
						1.1/2"	CP4-1.1/2"
						2"	CP4-2